

## SINGLE SUPPLY QUAD COMPARATOR

### ■ GENERAL DESCRIPTION

The NJM12901 is single-supply quad voltage comparator, which can operate from 2V supply. The features are low input offset voltage, low input bias current and low current consumption. The NJM12901 compare the input signal to 0V ( ground ) due to the Darlington PNP input stage.

The package lineup is DIP, DMP and others compact, so that the NJM12901 is suitable for any kind of signal comparator.

### ■ PACKAGE OUTLINE

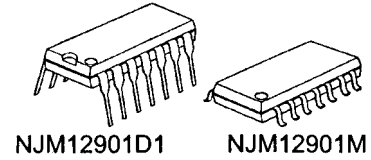

### ■ FEATURES

- Operating Voltage ( +2V~+14V )
- Open Collector Output
- Bipolar Technology
- Package Outline DIP14,DMP14,EMP14,SSOP14

### ■ PIN CONFIGURATION

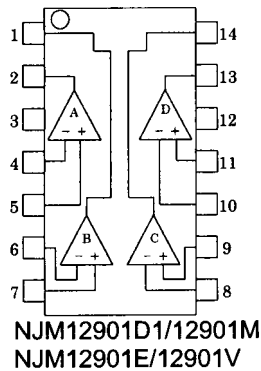

#### PIN FUNCTION

- |                  |             |
|------------------|-------------|
| 1.B OUTPUT       | 8.C -INPUT  |
| 2.A OUTPUT       | 9.C +INPUT  |
| 3.V <sup>+</sup> | 10.D -INPUT |
| 4.A -INPUT       | 11.D +INPUT |
| 5.A +INPUT       | 12.GND      |
| 6.B -INPUT       | 13.D OUTPUT |
| 7.B +INPUT       | 14.C OUTPUT |

### ■ EQUIVALENT CIRCUIT ( 1/4 Shown )

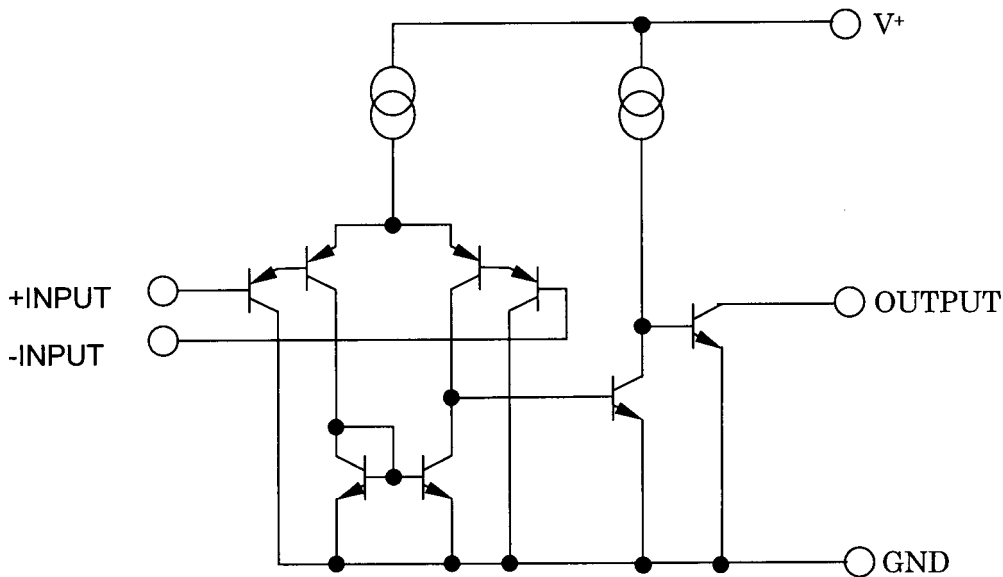

# NJM12901

## ■ ABSOLUTE MAXIMUM RATINGS

( Ta=25°C )

PARAMETER	SYMBOL	RATINGS	UNIT
Supply Voltage	$V^+$	15	V
Differential Input Voltage	$V_{ID}$	14	V
Input Voltage	$V_{IC}$	-0.3~+14	V
Power Dissipation	$P_D$	( DIP14 ) 700 ( DMP14 ) 300 ( EMP14 ) 300 ( SSOP14 ) 300	mW
Operating Temperature Range	$T_{opr}$	-40~+85	°C
Storage Temperature Range	$T_{stg}$	-50~+125	°C

## ■ ELECTRICAL CHARACTERISTICS

(  $V^+=5V, Ta=25^\circ C$  )

PARAMETER	SYMBOL	TEST CONDITION	MIN.	TYP.	MAX.	UNIT
Operating Voltage	$V_{opr}$		2	-	14	V
Input Offset Voltage	$V_{IO}$	$R_S=0\Omega, V_O=1.4V$	-	1	4	mV
Input Offset Current	$I_{IO}$		-	5	50	nA
Input Bias Current	$I_B$		-	30	200	nA
Input Common Mode Voltage Range	$V_{ICM}$		0~3.5	-	-	V
Large Signal Voltage Gain	$A_V$	$R_L=15k\Omega$	-	106	-	dB
Response Time	$t_R$	$R_L=5.1k\Omega$	-	0.5	-	$\mu s$
Output Sink Current	$I_{SINK}$	$V_{IN}^-=1V, V_{IN}^+=0V, V_O=1.5V$	6	10	-	mA
Output Saturation Voltage	$V_{SAT}$	$V_{IN}^-=1V, V_{IN}^+=0V, I_{SINK}=3mA$	-	80	300	mV
Leakage Current	$I_{LEAK}$	$V_{IN}^-=0V, V_{IN}^+=1V, V_O=5V$	-	0.1	1.0	$\mu A$
Operating Current	$I_{CC}$	$R_L=\infty$	-	0.8	1.8	mA

## ■ TYPICAL CHARACTERISTICS

NJM12901 Operating Current vs. Operating Voltage

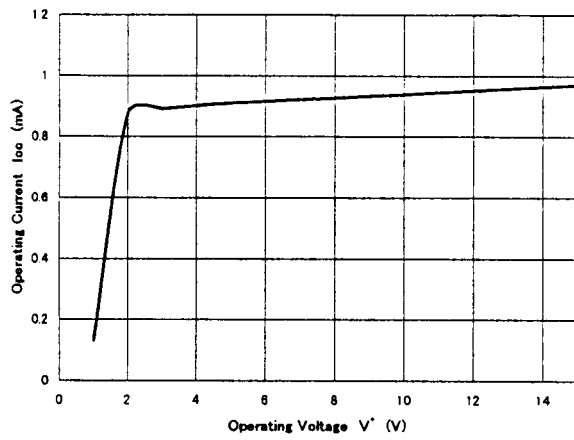

NJM12901 Output Saturation Voltage vs. Output sink Current

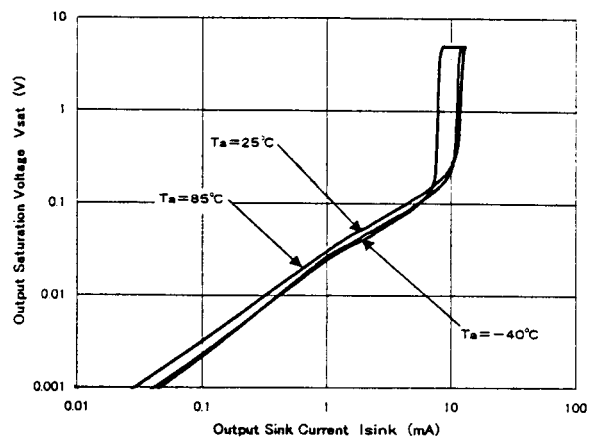

NJM12901 Input Offset Voltage vs. Operating Voltage

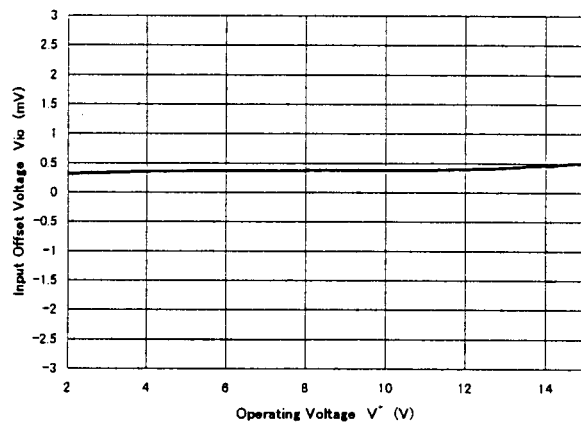

NJM12901 Input Bias Current vs. Operating Voltage

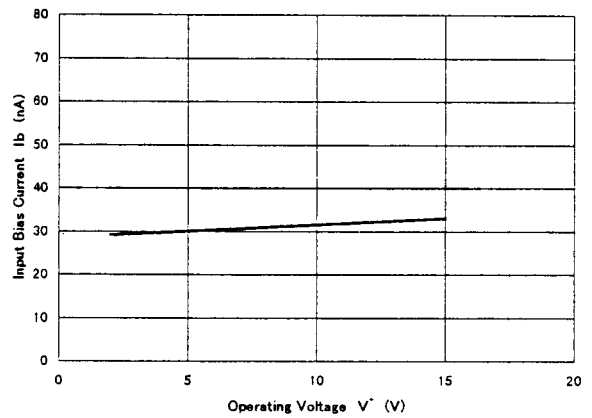

NJM12901 Output Saturation Voltage vs. Operating Voltage

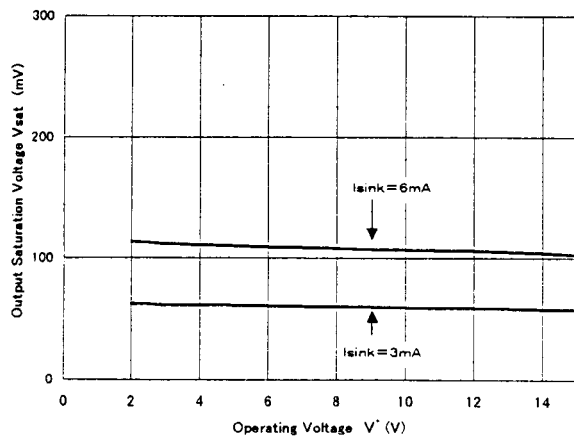

NJM12901 Input Common Mode Voltage Range

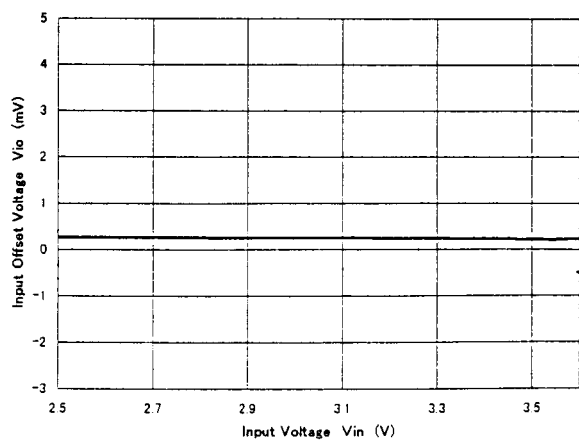

# NJM12901

## ■ TYPICAL CHARACTERISTICS

NJM12901 Operating Current vs. Temperature

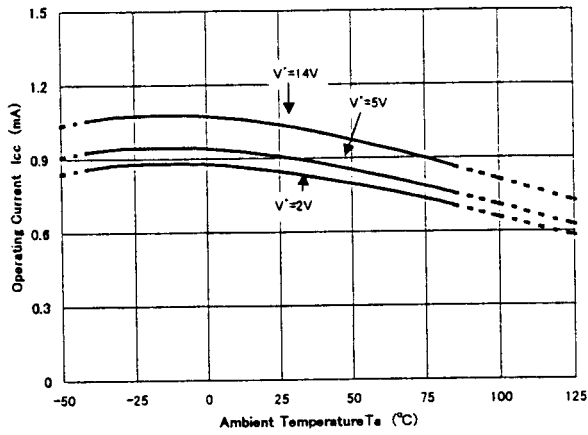

NJM12901 Input Bias Current vs. Temperature

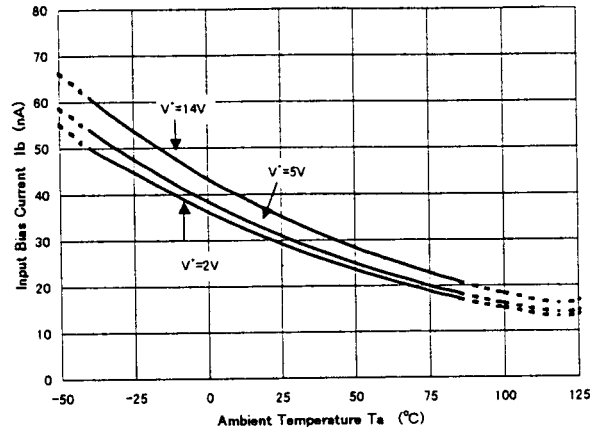

NJM12901 Input Offset Voltage vs. Temperature

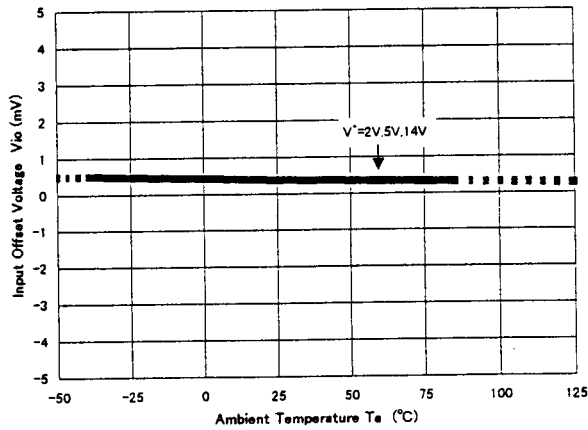

NJM12901 Output Saturation Voltage vs. Temperature  
( $I_{sink}=3mA$ )

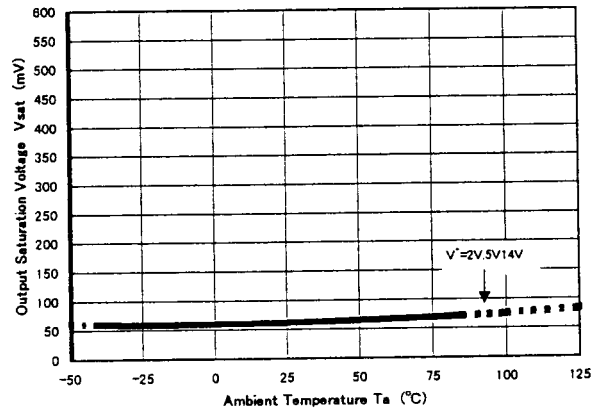

NJM12901 Pulse Response

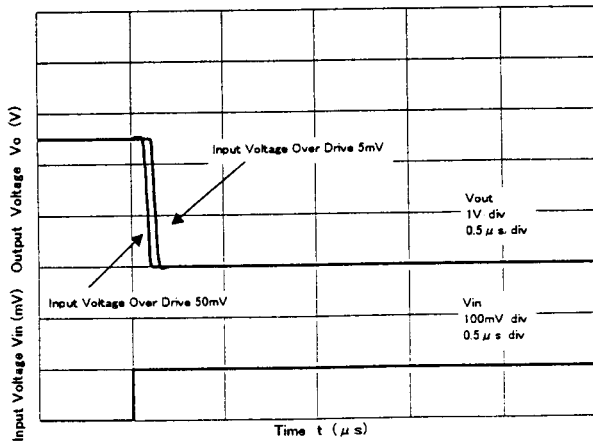

NJM12901 Pulse Response

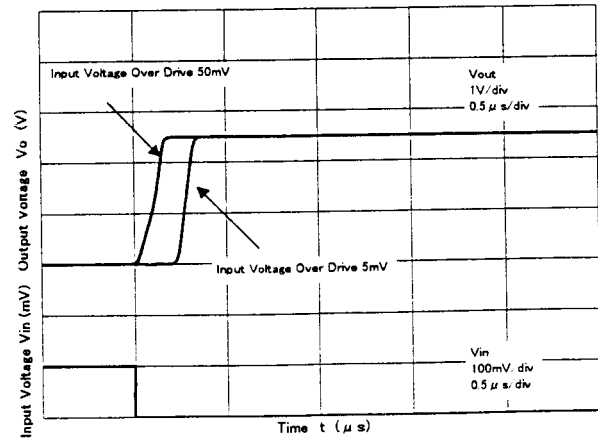

**[CAUTION]**

The specifications on this databook are only given for information, without any guarantee as regards either mistakes or omissions. The application circuits in this databook are described only to show representative usages of the product and not intended for the guarantee or permission of any right including the industrial rights.